



**INSTALLATION INSTRUCTIONS**  
**CANAM MAVERICK TRAIL/SPORT & 2021 COMMANDER**  
**REAR WINDSHIELD - VENT**  
**PART # 78-2600-R**

**IMPORTANT NOTICES**

**READ AND UNDERSTAND THESE INSTRUCTIONS COMPLETELY BEFORE INSTALLATION TO AVOID INJURY TO YOURSELF, DAMAGE TO THE VEHICLE OR ACCESSORY.**

- For proper installation, **TWO** people are required.
- Torque specifications must be followed when tightening bolts. Over-tightening any and/or all screws will cause cracks around mounting holes which is not covered by any warranty.
  - As specified on carton label, once protective film on shields is removed, product cannot be returned.
- As specified on carton label, damage caused by packaging staples is not covered by warranty. All staples must be removed prior to removing product from carton.
  - ANY cutting, trimming, drilling or altering of this product as delivered is not covered under warranty.
- Failure to follow these installation instructions completely may void any warrantable components and result in product damage or personal injury.
- Do not use Loctite/Super Glue or any other similar fastener adhesive. These types of products react to plastics and cause cracking. Not covered by any warranty.
  - Our windshields are made from the highest quality material providing optimum transparency and clarity. Blurriness and/or extrusion marks may or may not appear when looking through windshield from a wide, side-angle. This is normal for all extruded clear plastic materials.
- The application of improper cleaners, abrasive and/or dirty cleaning towels can severely damage the product. Failure to follow cleaning recommendation (provided herewith) may void any warrantable components.

**DEALER**

These instructions contain important information for future reference and must be given to the customer at time of purchase or upon completion of installation.

**Parts List** (parts available with kit only and not available separately)

ITEM	PART NAME	DESCRIPTION	QTY
A	Windshield	CNC windshield cut-out made of 1/8" thick GE polycarbonate or equivalent	1
B	Vent assembly	Includes: 1 vent cover, 1 vent flap assembly, 1 rubber vent seal and 7 vent mounting screws	1
C	Co-extruded bulb seal (1/4")	Includes: 84" Co-extruded bulb seal (1/4") / #77-95BS [end user to cut to exact length]	1
INSTRUCTION BAG	D	Windshield Hardware Includes: 4 metal plate hooks, 4 phillips truss head screws M6 x 20 and 4 plastic shoulder washers M6	1

**1. Installation**

- a) Find a clean flat area where you can safely lay down the windshield (Item A). Partially remove the protective film on both sides and apply the co-extruded bulb seal (Item C) using manual pressure to ensure good adhesion and cut any excess.

Co-extruded bulb seal 1/4"  
(+/- 83")

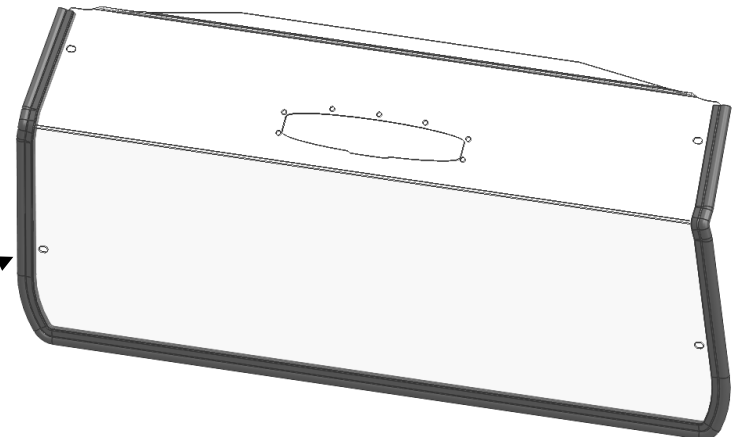

# IMPORTANT NOTICES

**Torque specifications must be followed when tightening bolts.**

**Over-tightening any and/or all screws will cause cracks around mounting holes which is not covered by any warranty.**

b) **Vent assembly (Item B) installation:** Partially remove the protective film on both sides of the windshield around the vent cutouts and follow instructions below.

a. From the front side (cab side) of the windshield, slide the vent flap assembly (Item B) in the vent cut out as shown in image b1. Ensure the lower tab nests into the front of the windshield as shown in image b2 & b3.

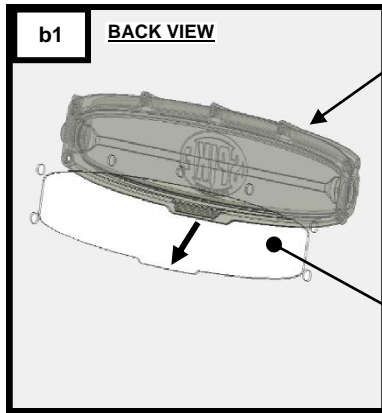
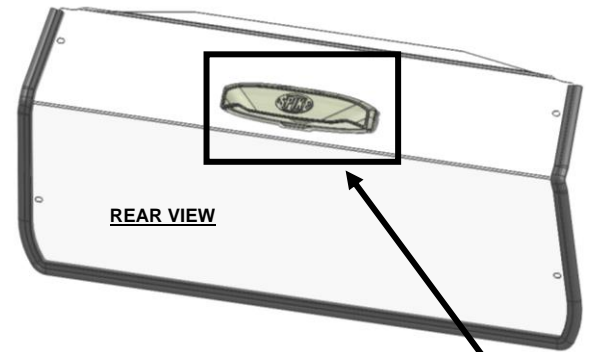

Vent flap assembly

Windshield vent cut out

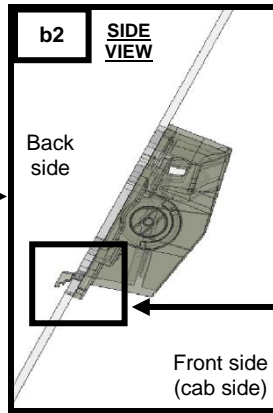

Back side

Front side (cab side)

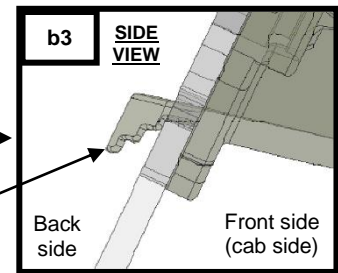

Lower tab

Back side

Front side (cab side)

b. Install the remaining vent components (Item B) using supplied hardware as shown below in image b4 & b5.

**Caution: over tightening any hardware could cause irreversible damage to the windshield.**

**DO NOT USE POWER TOOLS FOR THE INSTALLATION OF THE 7 MOUNTING SCREWS.**

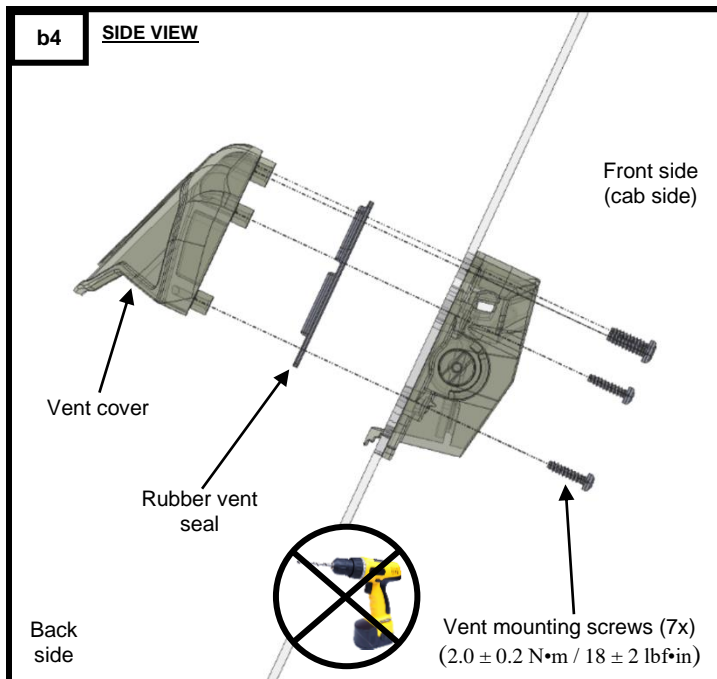

Front side (cab side)

Vent cover

Rubber vent seal

Back side

Vent mounting screws (7x)  
(2.0 ± 0.2 N•m / 18 ± 2 lbf•in)

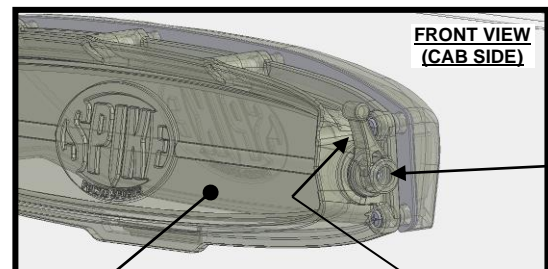

As shown on the front-view image, the **lever** is installed by default on the right side of the vent. Lever can be installed/relocated on left or right side of the vent. End user can decide.

Tightening/Loosening of the **screw** in the lever determines the force required for the **affle** adjustment.

## IMPORTANT NOTICES

Torque specifications must be followed when tightening bolts.

Over-tightening any and/or all screws will cause cracks around mounting holes which is not covered by any warranty.

## IMPORTANT NOTICES

**TWO people are required to install the windshield to the roll cage. Since windshield is wider at the bottom, gentle manipulation and/or slight bending by each person will be required for windshield to slide all the way down into position.**

**Warning: Exercise extreme care during the next step in order to ensure that you do not damage the windshield or vehicle. This is a tight fit.**

- c) Install the windshield to the vehicle as shown below.

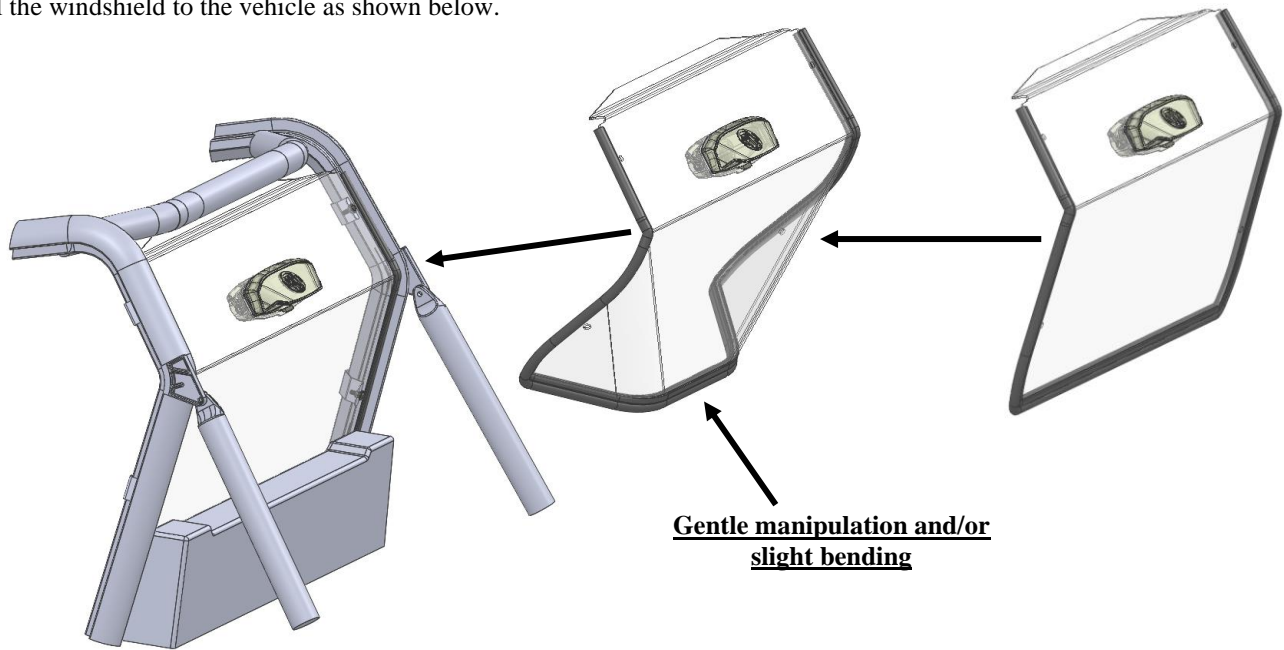

- d) Install the supplied hardware (Item D) as shown below. Adjust the position of the windshield and tighten.

**Caution: over tightening any hardware could cause irreversible damage to the windshield.**

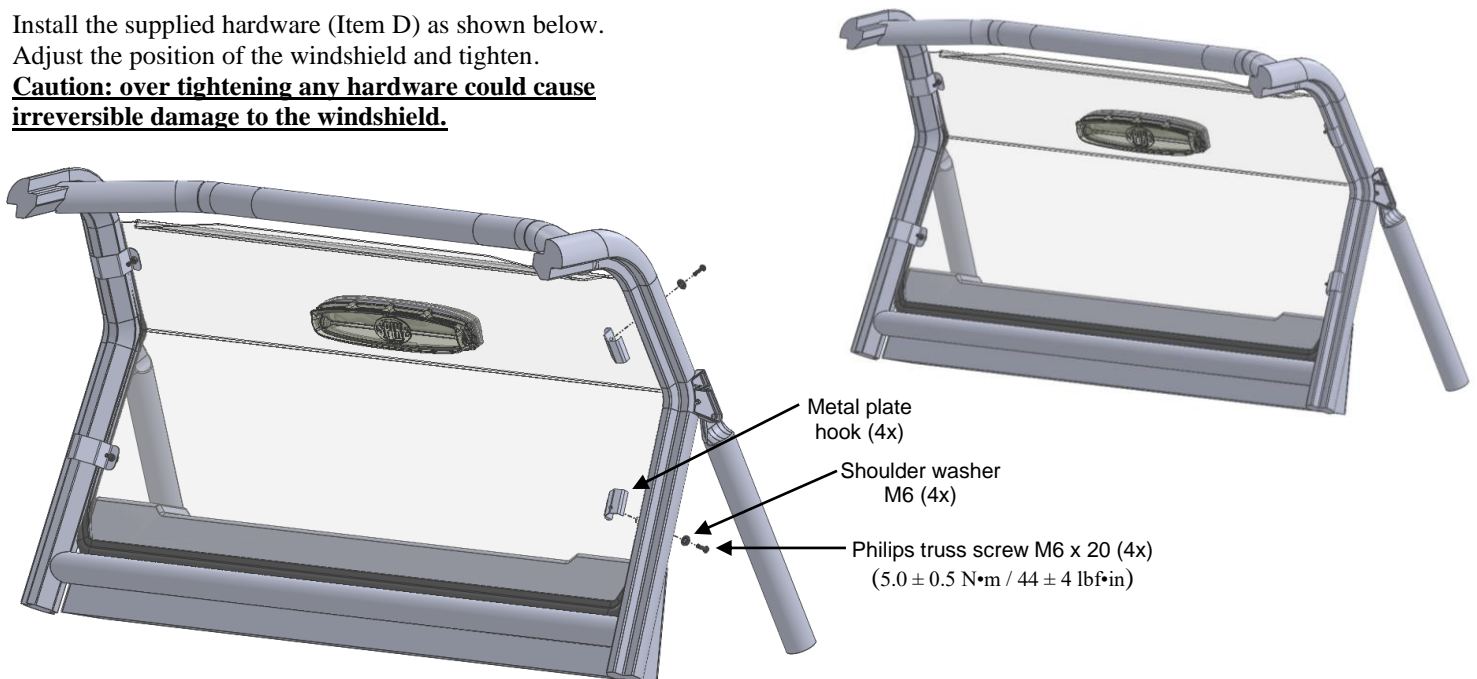

## IMPORTANT NOTICES

**Trailerable ONLY with a FULL Front windshield AND Roof - or damage can occur! Due to extreme wind turbulence, towing on an open trailer pulled by a motor home, bus or other large size vehicle at highway speeds is NOT recommended.**

### CAUTION

**Limited Towing at lower speeds (60mph or less) for shorter distances is acceptable with a FULL Front Windshield AND Roof ONLY. Prolonged towing at highway speeds on an Open trailer is NOT recommended and can cause damage that is NOT covered under Warranty. Whenever towing anytime, it is mandatory to check all windshield hardware BEFORE towing and at frequent intervals afterwards!**

**SPIKE suggests removal of Rear Windshields if towed in any conditions that are NOT recommended - removal will also create less drag on the tow vehicle**

## 2. Maintenance and Care

Tighten all hardware after first use and periodically thereafter.

### CLEANING:

- Rinse with lukewarm water; wash gently with mild soap or detergent and lukewarm water, using a soft cloth or sponge. **DO NOT SCRUB** or use brushes or squeegees.
  - Rinse again. Dry with soft cloth or moist cellulose sponge to prevent water spotting.
- To remove wet paint, glazing compound or grease, rub lightly with a good grade of VM&P naphtha or isopropyl alcohol, then wash and rinse. **DO NOT USE GASOLINE.**

**NOTICE:** Abusive cleaning procedures by hand washing or automated washing equipment will eventually result in visual hazing, loss of light transmission and coating delamination.

#### Compatible Cleaning Agents

- Aqueous Solution of Soaps and Detergents

[ Joy | Freon T.F. | Palmolive liquid | Top Job | VM&P grade Naphtha | Windex (with ammonia D) ]

### MINIMIZING HAIRLINE SCRATCHES

For minimizing scratches and minor abrasions, mild automobile polish can be used.

Recommended products: Johnson Paste Wax, Novus Plastic Polish #1 and #2, Mirror Glaze plastic polish and Plexux1.

Testing polish on a separate Lexan sample is recommended. Be sure to follow product instructions carefully.